

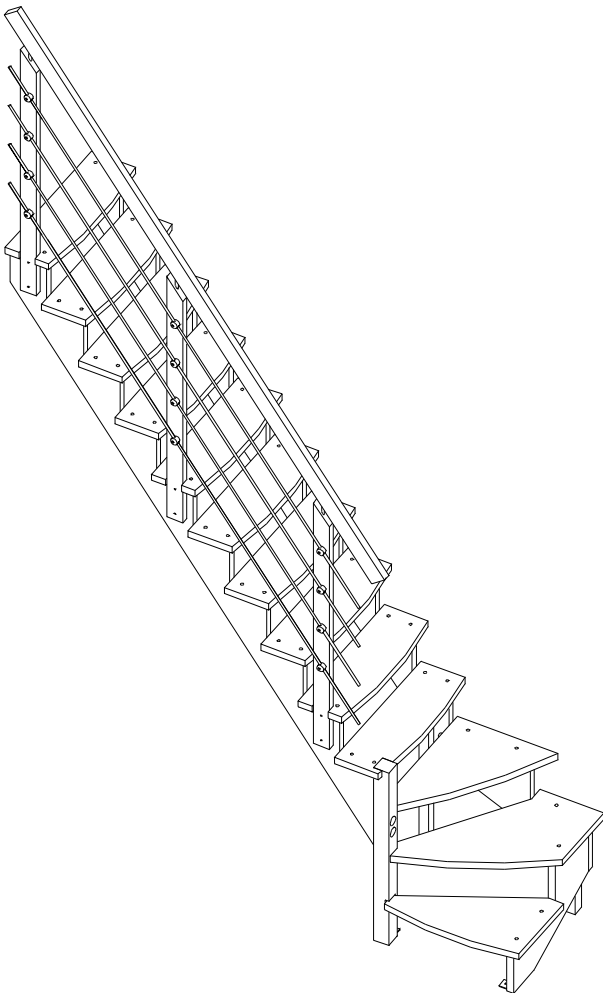

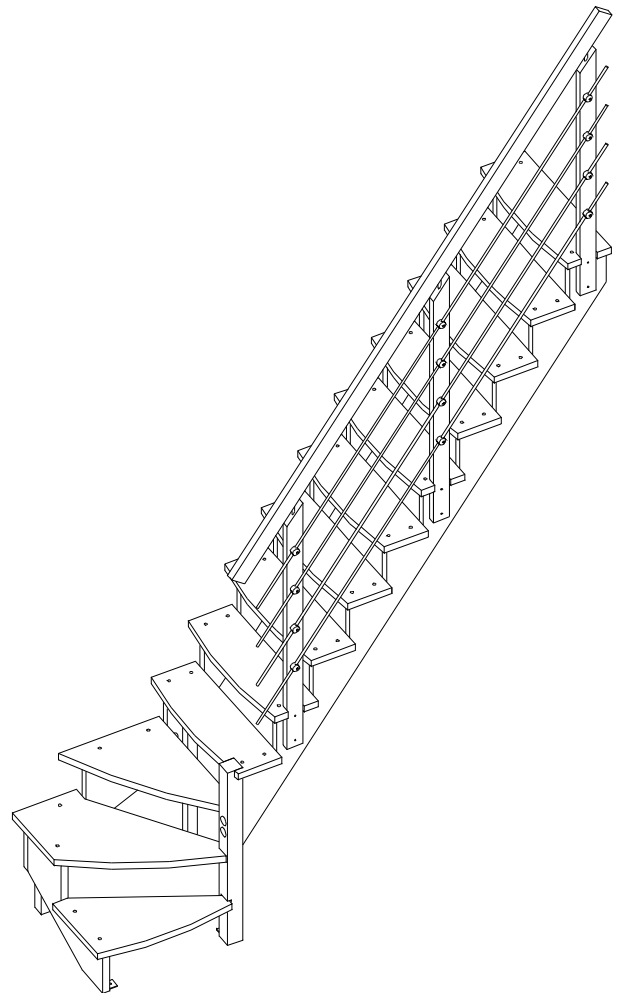

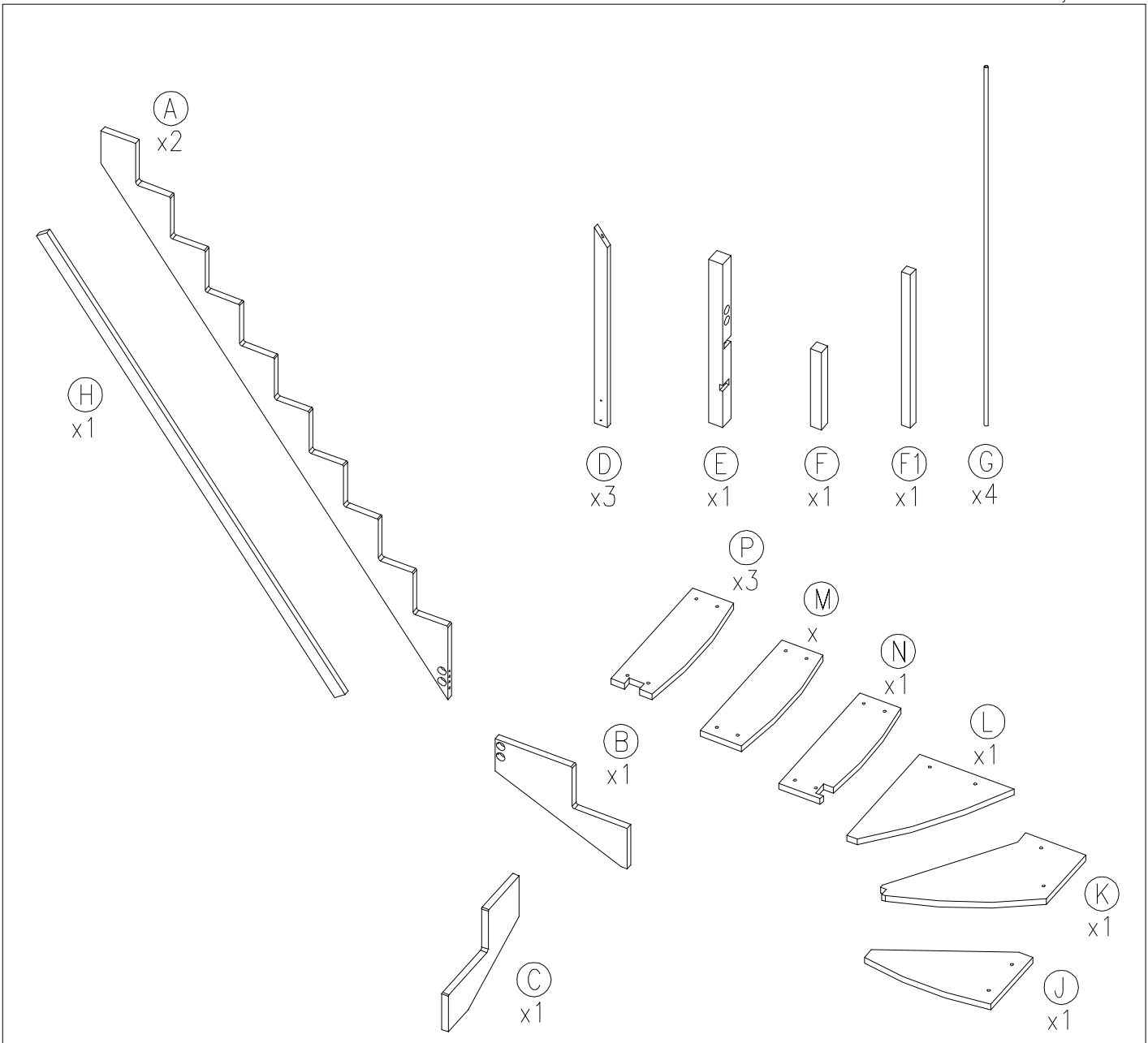









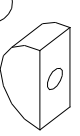

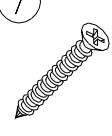
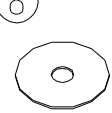

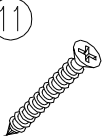

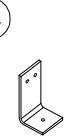
**Laufrichtung**  
**Abb.: Linkslaufend**

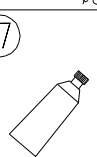

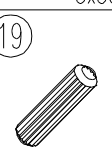
**Laufrichtung**  
**Abb.: Rechtslaufend**

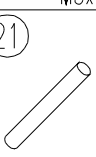



①  x4 6x50	②  x4 10x50	③  x8 4,5x20	④  x2 $\varnothing$ 8x55	⑤  x6	⑥  x6 M8	⑦  x10 6x70	⑧  x2 $\varnothing$ 8/ $\varnothing$ 24
⑨  x1 $\varnothing$ 8	⑩  x46 $\varnothing$ 12	⑪  x52 5x50	⑫  x8 $\varnothing$ 40	⑬  x2 M8x70	⑭  x4	⑮  x12	⑯  x12 4,5x40
⑰  x1	⑱  x6 $\varnothing$ 8	⑲  x4 $\varnothing$ 10	⑳  x1	㉑  x3 $\varnothing$ 10x148	㉒  x6	㉓  x8	㉔  x1

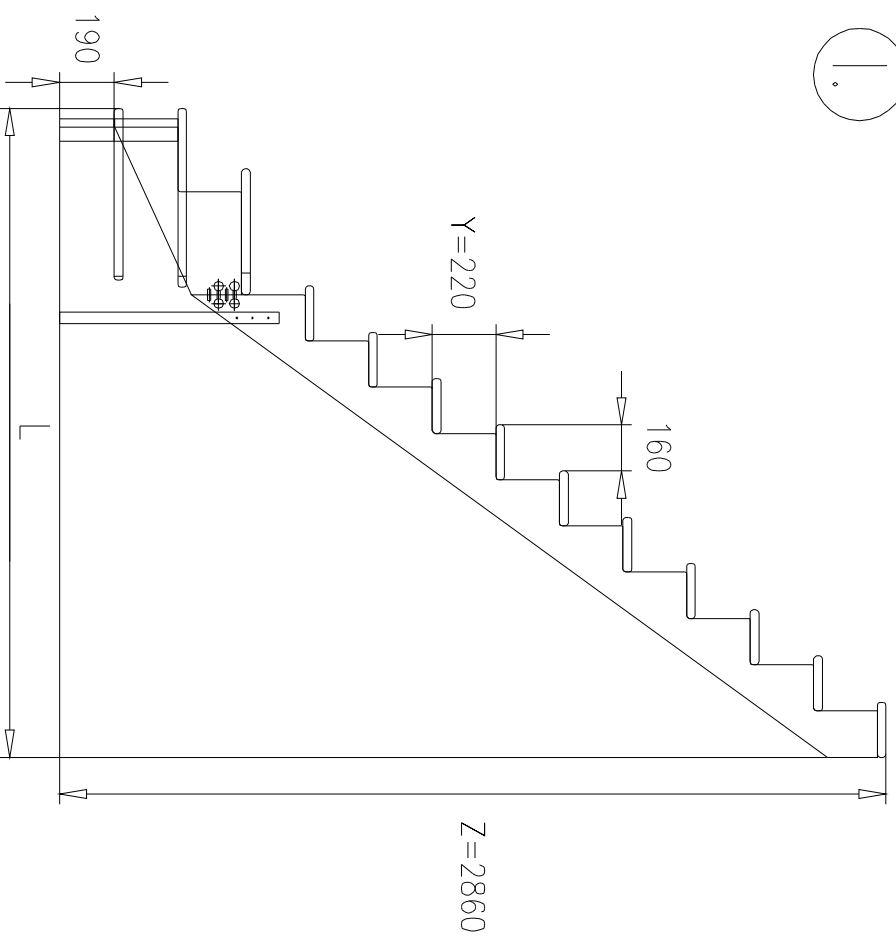
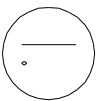

Y Steigung	Z Höhe
11	242.0 cm
12	264.0 cm
13	286.0 cm

Stufen	Y Steigung 22.0 cm	
	L Ausladung	
11	65.0 cm	75.0 cm
12	191.3	201.3
13	207.3	217.3
	223.3	233.3

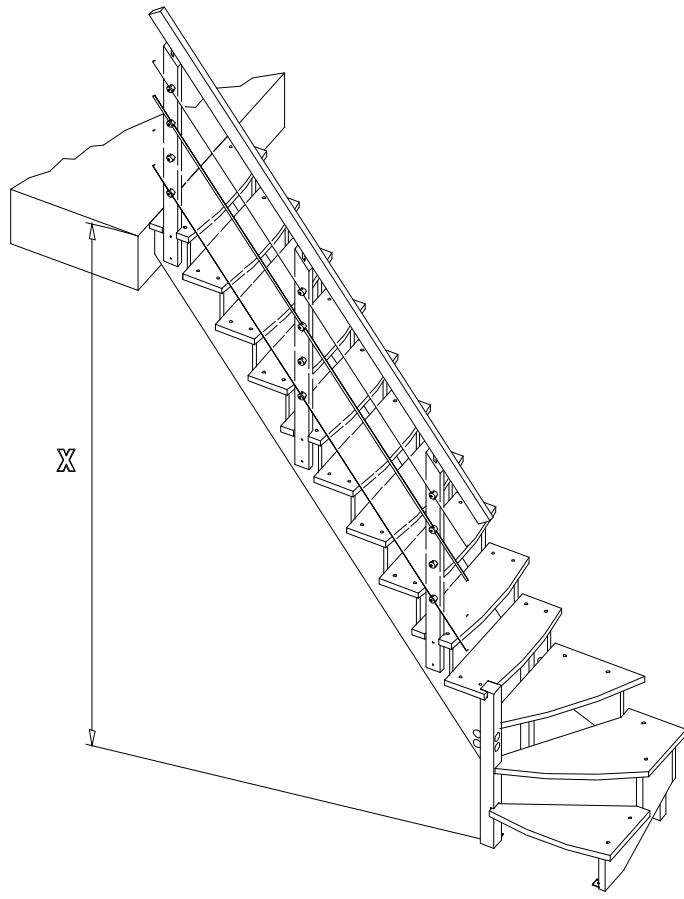

Z-X=T

X

1

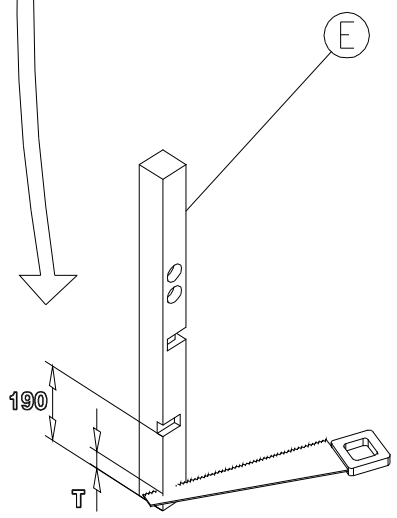

2

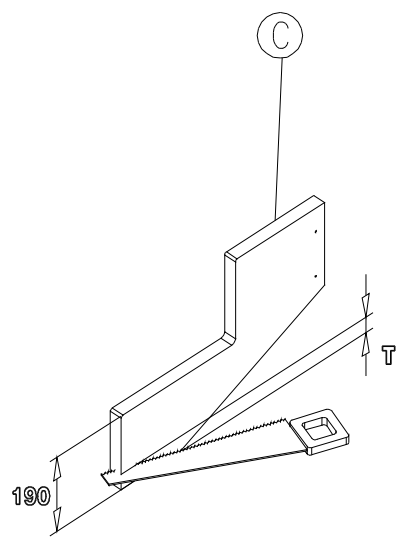

3

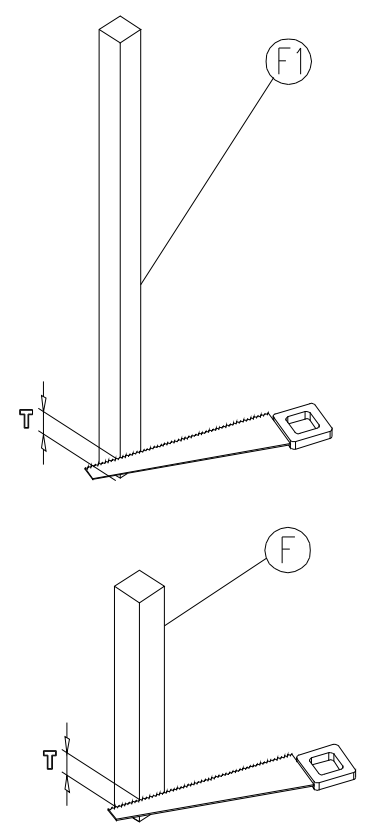

4

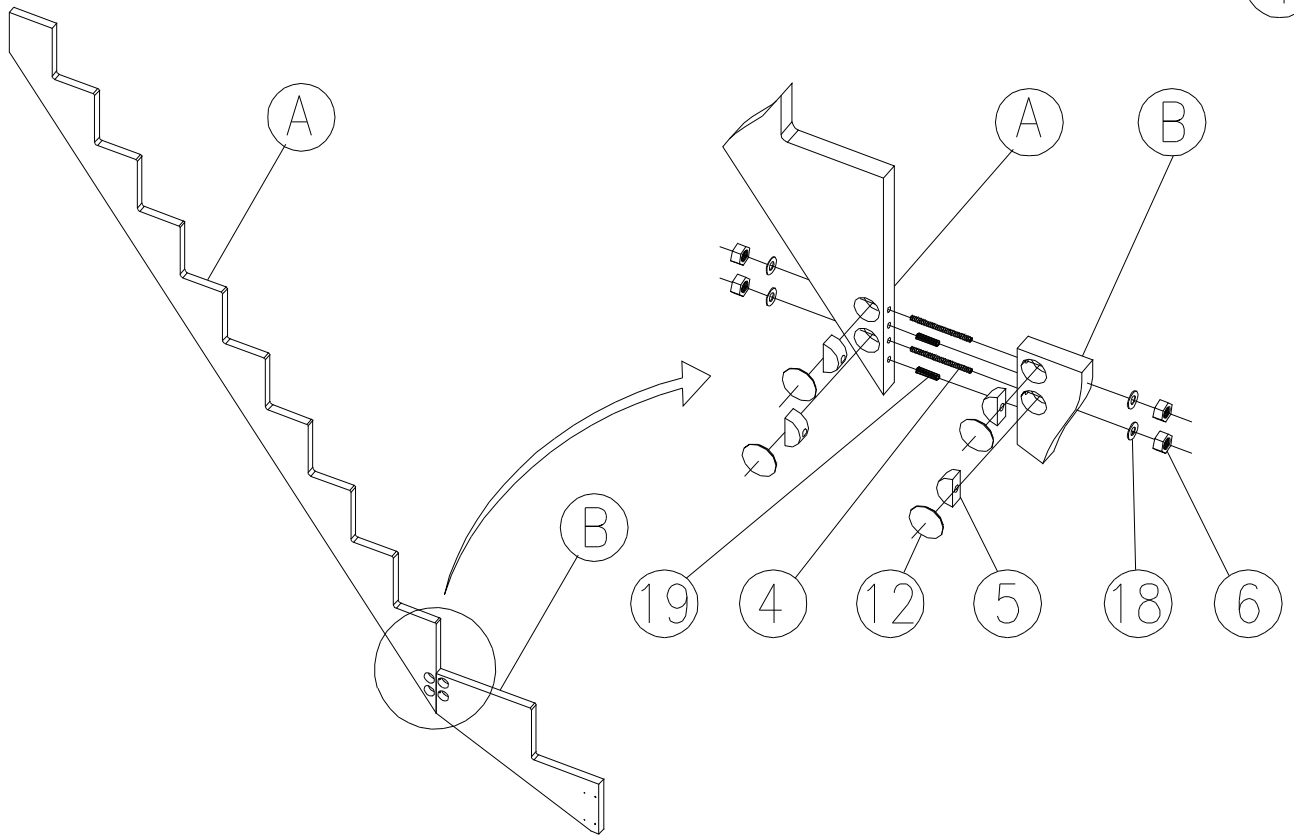

5

